

A75Q-500DP2X-POCB1 - Digital Ferrous Metal Detection Sensor

1/2" Extended Permanent Magnet Prox Sensor, pnp open collector output, Aluminum 3/4-20 x 3" housing, Integral Flange 4 pin male 12mm micro connector

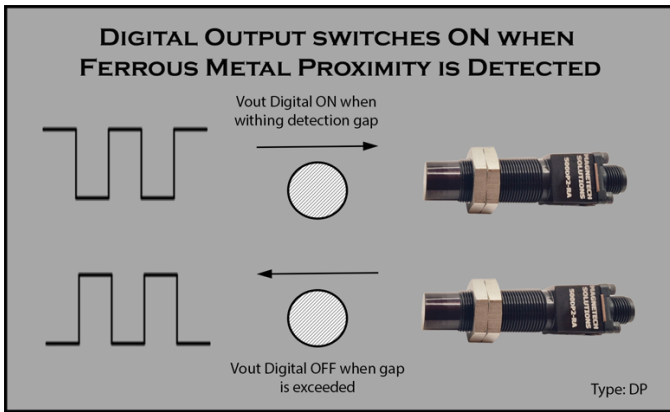

- o TRUE ZERO SPEED
- o LARGE DETECTION GAP
- o INTERNAL HYSTERESIS
- o DETECTS THROUGH ALUMINUM

ENVIRONMENTAL SPECIFICATIONS A75Q HOUSING

Corrosion Resistance	500 hours salt spray ASTM B-117
Installation Torque	35 ft-lbs maximum
Enclosure	Nema, 1,3,4,6, & IEC IP67
Vibration	10 G's 2 to 2000 Hz Sinusodal
Mechanical Shock	100 G's, 11mS Half-Sine

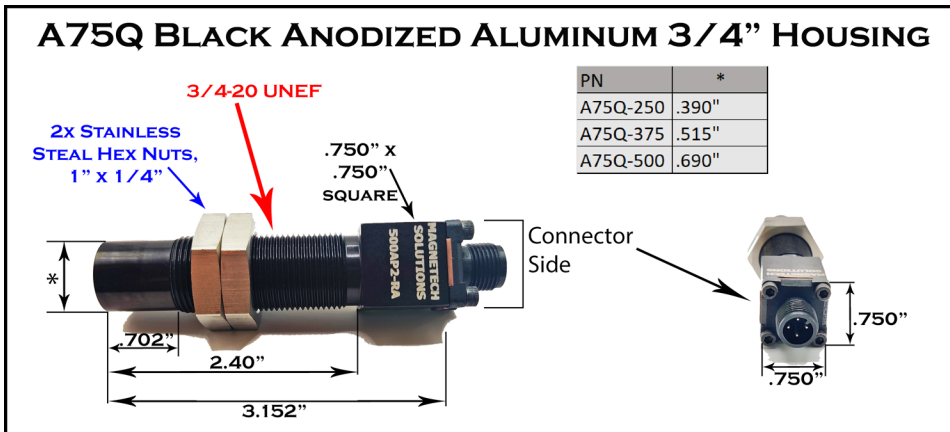

PO, OPEN COLLECTOR PNP

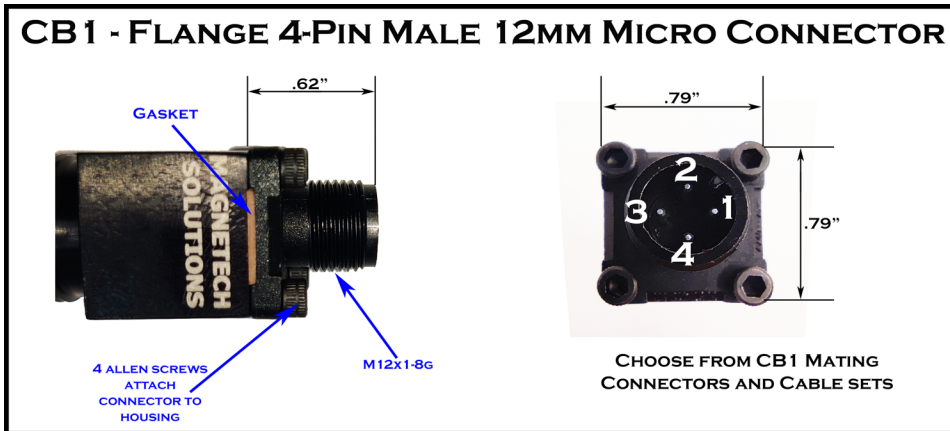
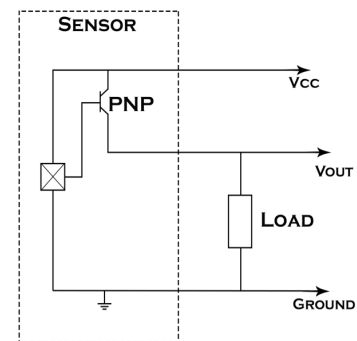

Connections Chart	
Pin 1	Vcc
Pin 2	Analog Vout
Pin 3	Ground
Pin 4	Digital Vout

CB1-500DP2X

Date Code 'YYM'			
YY = YEAR, M = MONTH			
A JAN	D APR	H JUL	L OCT
B FEB	E MAY	J AUG	M NOV
C MAR	G JUN	K SEP	N DEC

This product line of Proximity Sensors is ideally suited for applications where it is desired to detect the presence or movement of Ferrous Metals and ignore Non-Ferrous Metals like aluminum. They provide a digital output signal that switches ON when a ferrous metal target is near the sensor's face. This 500DP2X sensor has an .500" diameter internal magnet that creates a magnetic field around the face of the sensor.

The presence of any ferrous metal within the magnet's field in front of the Sensor's face increases the internal magnetic flux density. As the target is brought closer to the face, this flux increases exponentially. The sensor has an analog voltage that increases proportional to this flux increase, see the curves on page 2. When enough increase in flux is present, the analog voltage exceeds 2V and the digital output transistor turns ON.

The 500DP2X sensor is factory adjusted to switch ON when a large steel target is at a 1.0" gap or closer. There is an adjustment potentiometer behind the sensor's connector, contact MagneTech to discuss how this adjustment can be used to tune this sensor to specific needs.

These Digital Ferrous Metal Proximity Sensors are available with different magnet sizes ranging from 1/4" to 7/8". Smaller magnets are better suited to ignore other steel near the ferrous target of interest, larger magnets can detect targets at a farther gap. Contact us or check our web site www.magnetechsolutions.com to see all of our ferrous metal detection options.

A75Q-500DP2X-POCB1 - Digital Ferrous Metal Detection Sensor

1/2" Extended Permanent Magnet Prox Sensor, pnp open collector output, Aluminum 3/4-20 x 3" housing, Integral Flange 4 pin male 12mm micro connector

500DP2X-PO ELECTRICAL & FUNCTIONAL SPECIFICATIONS

Absolute Max Limits	MIN	MAX	Units
Supply Voltage, Vcc	-0.30	30.00	Volts DC
Voltage applied to output	-0.30	Vcc	Volts
Digital Output Clamp (Short Crkt Protection) Current	40.00	65.00	mA
Digital Output Short to ground, Vcc less than 28V	--	5.00	minutes
Load Dump, 40mS	--	45.00	Volts
Output Power, T=25C	--	1.00	W

Electrical Specs	Conditions	MIN	MAX	Units
Temperature Range	Operating	0.0	70.0	Deg C
Supply Voltage, Vcc	Over temperature	7.0	30.0	Volts DC
Supply current	Into Vcc, Vout Low	20.0	64.0	mA
Frequency Range		0.0	6.0	kHz
Digital Voltage Low (VoL)	Vcc=12, Rload = 1K	0.0	0.1	Volts
Digital Voltage High (VoH)	Vcc=12, Rload = 1K	10.5	12.0	Volts
Pull Down Resistor	Internal, Vout to Gnd	NONE	NONE	kOhms
Output Rise time 10-90%	C <100pF	--	1.0	uS
Output Fall time 90-10%	C <100pF	--	5.0	uS
Analog Output Resistance		--	25.0	Ohms
Analog Output Current		--	20.0	mA

Functional Characteristics	MIN	TYP	MAX	Units
Detects Large Steel Target, from .000" to:	0.90	1.000	1.10	Inches
Hysteresis, Large Steel Target	--	0.05	--	Inches
Detect 0.5" from Steel Target	--	0.80	--	Inches
Detect 0.1" from Steel Target	--	0.45	--	Inches

Bold indicates 100% factory tested before shipment

*Factory Tested at 25C

THESE SENSORS HAVE AN INTERNAL 'SENSITIVITY ADJUSTMENT' POTENTIOMETER.

TO CHANGE THE SENSITIVITY:

1. REMOVE THE 4 ALLEN SCREWS FROM THE SENSOR'S CONNECTOR TO EXPOSE ADJUSTMENT POT

2. APPLY POWER TO THE SENSOR, AND MONITOR 'ANALOG VOUT' VOLTAGE WITH A VOLTMETER

3. TO INCREASE SENSITIVITY, TURN THE POT CLOCKWISE. TO DECREASE, TURN COUNTER-CLOCKWISE

ADJUSTMENT
POTENTIOMETER

REMOVE CONNECTOR

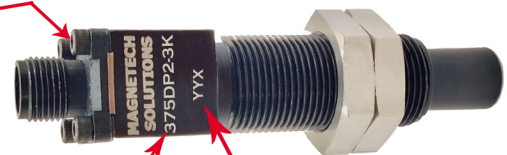
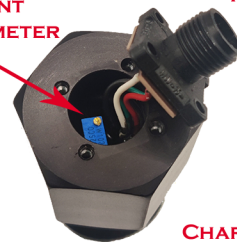

CHARACTERISTIC OPTION

DATE CODE

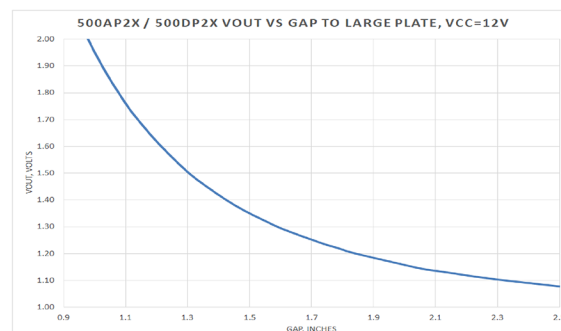
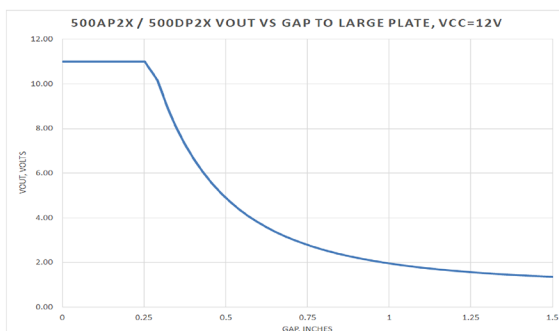

NOTE: METAL SHAVINGS WILL STICK TO THE NOSE OF THE SENSOR AND INCREASE THE SENSOR'S ANALOG OUTPUT VOLTAGE. PERIODICALLY CHECK AND REMOVE ALL SHAVINGS TO ENSURE ACCURATE SENSOR READINGS.