

A12-870AP2-RACB115M - Analog Ferrous Metal Position Sensor

Analog Ferrous Distance Sensor, 7/8" magnet, regulated input, 0-Vcc analog output, Aluminum 1 1/4-18 x 3.5" housing, 12mm micro connector on 1.5m PUR 22AWG Cable

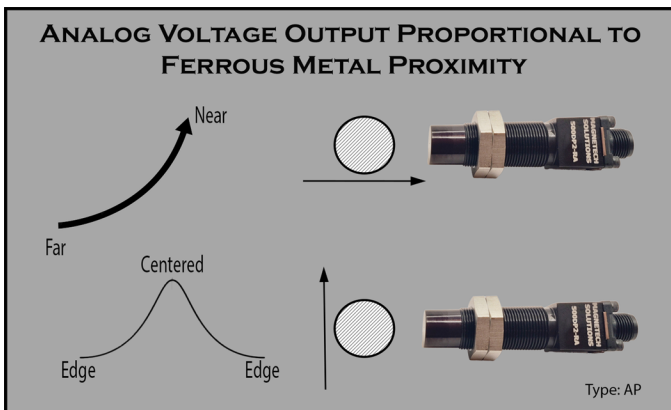

- o TRUE ZERO SPEED
- o LARGE DETECTION GAP
- o INTERNAL HYSTERESIS
- o DETECTS THROUGH ALUMINUM

ENVIRONMENTAL SPECIFICATIONS A12 HOUSING

Corrosion Resistance	500 hours salt spray ASTM B-117
Installation Torque	35 ft-lbs maximum
Enclosure	Nema, 1,3,4,6, & IEC IP67
Vibration	10 G's 2 to 2000 Hz Sinusoidal
Mechanical Shock	100 G's, 11mS Half-Sine

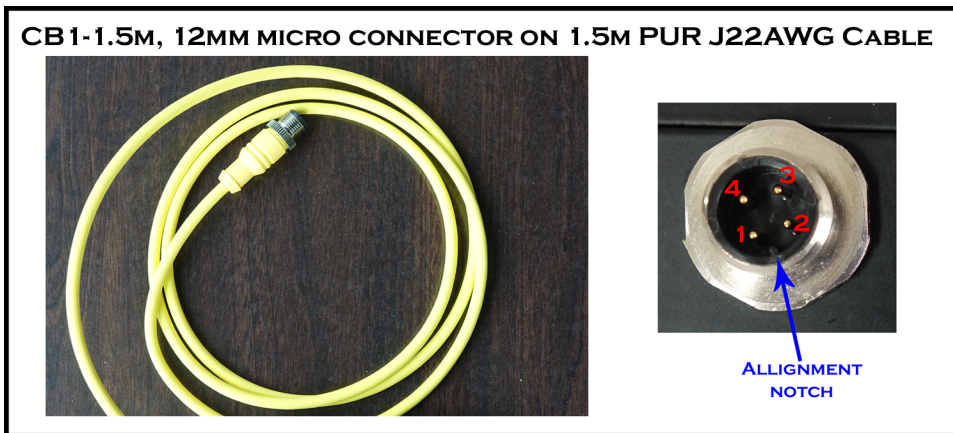
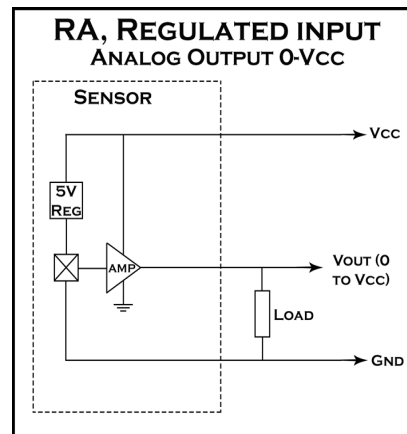
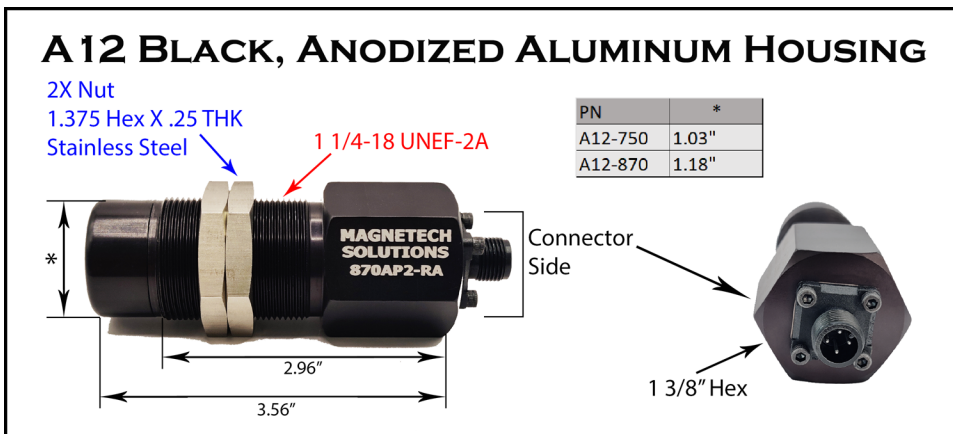

Connections Chart	
Pin 1	Vcc
Pin 2	Analog Vout
Pin 3	Ground
Pin 4	Open

CB1-870AP2

Date Code 'YYM'			
YY = YEAR, M = MONTH			
A JAN	D APR	H JUL	L OCT
B FEB	E MAY	J AUG	M NOV
C MAR	G JUN	K SEP	N DEC

The -870AP2 (analog voltage output) sensors have a .870" diameter internal magnet that creates a magnetic field in front of the sensor. When ferrous metal is present within the magnet's field, the sensor's internal flux density changes. Any steel in front of the sensor's nose increases this flux. When enough increase in flux is present, the analog output increases. These -870AP2 sensors will start to detect a large steel plate at around a 2.60" gap. The ferrous content, shape, & size of the target will affect the operating gap range. As the target gets closer to the sensor's nose, the flux increases exponentially. See the curves on page 2.

The analog voltage is factory adjusted to 1.0 volts with no metal present. To adjust these sensors, remove the Allen screws at the connector to access the adjustment pot. For the greatest range, adjust the output with no target present back to 1.0 volts. This is a 12 turn pot, and it may require a few turns to reach the desired output. Clockwise turns increase the offset voltage.

Analog Output Linear sensors are available in multiple sizes, which each have a different maximum detection gap. Note that mounting sensors close to each other will not impair their ability to function properly, but will change the output with no target present. This change in output with no magnet present can be corrected for by accessing the adjustment potentiometer located behind the connector (see page 2). Contact us or check our web site www.magnetechsolutions.com to see all of our analog output ferrous metal detection options.

A12-870AP2-RACB115M - Analog Ferrous Metal Position Sensor

Analog Ferrous Distance Sensor, 7/8" magnet, regulated input, 0-Vcc analog output, Aluminum 1 1/4-18 x 3.5" housing, 12mm micro connector on 1.5m PUR 22AWG Cable

870A2-RA ELECTRICAL & FUNCTIONAL SPECIFICATIONS

Absolute Max Limits	MIN	MAX	Units
Supply Voltage, Vcc	-0.30	30.00	Volts DC
Voltage applied to output	-0.30	Vcc	Volts
Short Circuit to Ground	--	indef.	Seconds
Load Dump, 40mS	--	45.00	Volts

Electrical Specs	Conditions	MIN	MAX	Units
Temperature Range	Operating	0.0	70.0	Deg C
Supply Voltage, Vcc	Over temperature	7.0	30.0	Volts DC
Supply current	Into Vcc	15.0	50.0	mA
Frequency Range		0.0	6.0	kHz
Analog Output Resistance		--	25.0	Ohms
Analog Output Current		--	20.0	mA
Analog Output Range	Rload>10k	0.05	Vcc - .05	Volts

Functional Characteristics	MIN	TYP	MAX	Units
Analog Output, no steel present*	0.90	1.00	1.10	Volts
Analog Output at 1/2" (large target)	2.75	3.10	3.45	Volts
Potentiometer adjust range, 12 turn	0.20		5.00	Volts

*Factory Tested at 25C

THESE SENSORS HAVE AN INTERNAL 'SENSITIVITY ADJUSTMENT' POTENTIOMETER.

TO CHANGE THE SENSITIVITY:

1. REMOVE THE 4 ALLEN SCREWS FROM THE SENSOR'S CONNECTOR TO EXPOSE ADJUSTMENT POT

2. APPLY POWER TO THE SENSOR, AND MONITOR 'ANALOG VOUT' VOLTAGE WITH A VOLTMETER

3. TO INCREASE SENSITIVITY, TURN THE POT CLOCKWISE. TO DECREASE, TURN COUNTER-CLOCKWISE

ADJUSTMENT
POTENTIOMETER

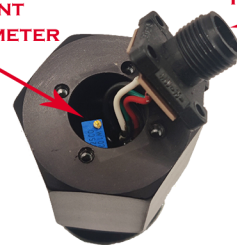

REMOVE CONNECTOR

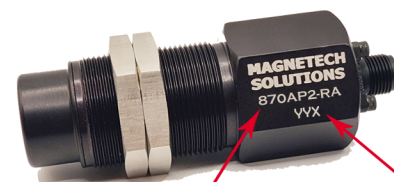

CHARACTERISTIC OPTION

DATE CODE

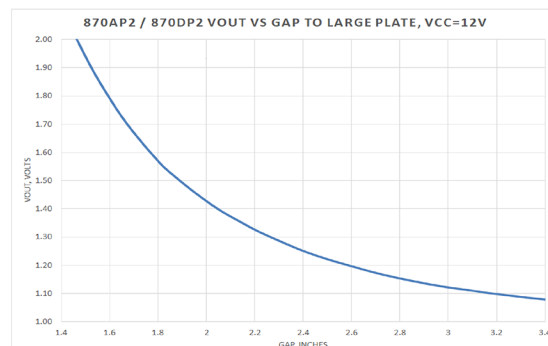
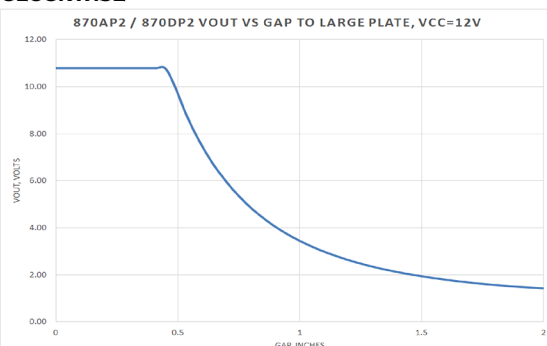

NOTE: METAL SHAVINGS WILL STICK TO THE NOSE OF THE SENSOR AND INCREASE THE SENSOR'S ANALOG OUTPUT VOLTAGE. PERIODICALLY CHECK AND REMOVE ALL SHAVINGS TO ENSURE ACCURATE SENSOR READINGS.